

VC2020VGBCFN1 Datasheet

iC LED Series (L* W*H): 2.0*2.0*0.75mm



Applications

- Telecommunication, office automation, home appliances, industrial equipment
- Full-color strip
- Consumer electronics
- Other applications

Features

- Serial data transmission signal by (DATA CLK) two line.
- One pixel contains R, G, and B color that each can achieve 256 level brightness grayscale, which forms 16, 777, 216 combination colors.
- Supports sleep /wake-up mode. In sleep mode, the LED's current was lower than 5uA
- Lens color: water transparent
- RoHS2.0 and REACH-compliant
- ESD level 6kV(HBM)
- Preconditioning: accelerate to JEDEC level 3
- Typical view angle 50% Iv:120°
- Reliability Test: AEC Q-102/AEC Q100qualified

VC2020VGBCFN1

Dimensional Drawing

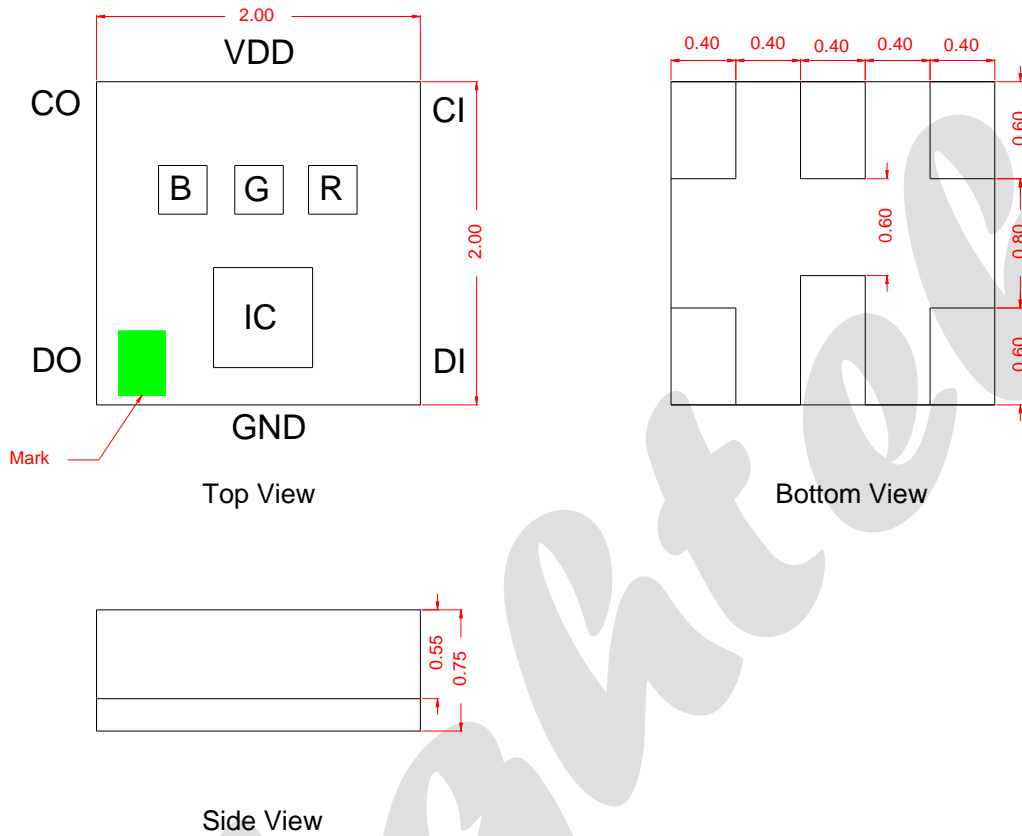

RECOMMEND PAD LAYOUT

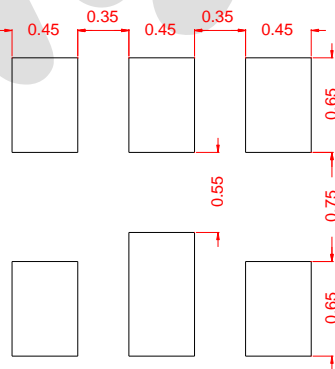

1. Dimensions are in millimeters.
2. General tolerance is $\pm 0.1\text{mm}$.

VC2020VGBCFN1

PIN Configuration

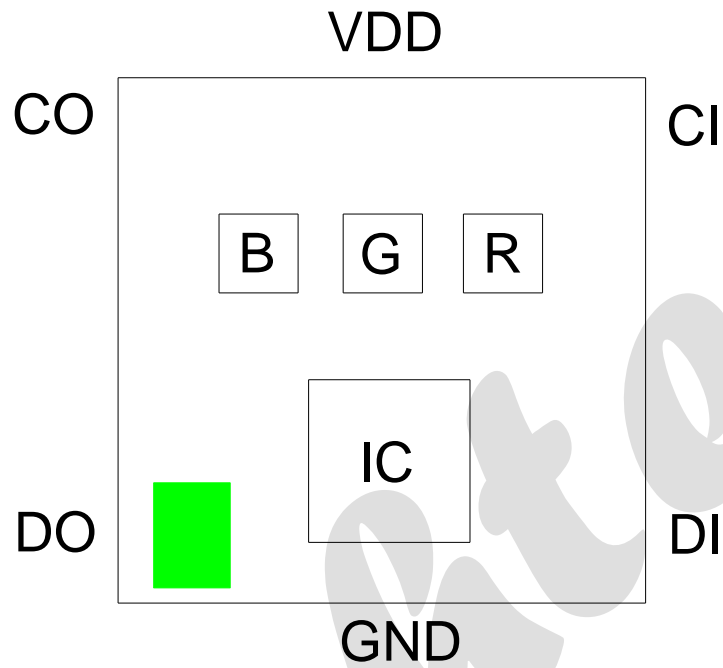

| No. | Symbol | Function description |
|-----|--------|----------------------|
| 1 | CO | Clock output |
| 2 | VDD | supply voltage |
| 3 | CI | Clock input |
| 4 | DO | Data output |
| 5 | GND | Ground |
| 6 | DI | Data input |

VC2020VGBCFN1

Naming Rule

VC-2020-VGB-C-F-N1

| VC | 2020 | VGB | C | F | N1 |
|--------------------|-----------------|----------------------------|--------------------------|----------------|-------------------|
| Type | Package Size | Color | Lens color | Output current | Serial number |
| VC: With IC Series | 2020: 2.0*2.0mm | V:red G:green B:blue | C : water transparent | F:20mA | N1: Serial number |

Maximum Ratings

T_A : 25 °C

| Parameter | Symbol | Values | Unit |
|----------------------------|-----------------|--------------|------|
| IC Power Supply Voltage | VDD | < 6.5 | V |
| LED voltage | V led | 4.5-5.5 | V |
| Rate of data signal | FCLK | 15 | MHZ |
| The max led output Current | IOMAX | 20 / channel | mA |
| Power dissipation; | PD | <400 | mW |
| Soldering temperature | T _{SD} | 260 | °C |

1. The maximum of soldering time is 10 seconds in T_{SD}.

VC2020VGBCFN1

Characteristics

VDD:5V | T_A : 25 °C

| Characteristics | Symbol | Min. | Typ. | Max. | Unit | Test condition | |
|---------------------|-------------------|------|------|------|------|----------------|--------|
| Luminous Intensity | I _v | R | 220 | 280 | 350 | mcd | VDD=5V |
| | | G | 700 | 850 | 1050 | | |
| | | B | 120 | 150 | 200 | | |
| Dominant Wavelength | λ _d | R | 630 | - | 636 | nm | VDD=5V |
| | | G | 524 | - | 529 | | |
| | | B | 455 | - | 460 | | |
| View Angle | 2θ _{1/2} | - | 120 | - | deg | VDD=5V | |

1. Luminous intensity is measured with a light sensor and filter combination that approximates the CIE eye-response curve.
2. 2θ_{1/2} is the off-axis angle at which the luminous intensity is half the axial luminous intensity.
3. The dominant wavelength, λ_d is derived from CIE chromaticity diagram and represents the single wavelength which defines the color of the device. Peak Emission Wavelength Tolerance is ±1nm.

VC2020VGBCFN1

Bin groups

1. Luminous Intensity

VDD:5V | IF : 20mA

| Bin Code | | Min. IV (mcd) | Max. IV (mcd) |
|----------|---|------------------|------------------|
| V | 1 | 220 | 280 |
| | 2 | 280 | 350 |
| G | 1 | 700 | 850 |
| | 2 | 850 | 1050 |
| B | 1 | 120 | 150 |
| | 2 | 150 | 200 |

2. Chromaticity Coordinate Groups

VDD:5V | IF : 20mA

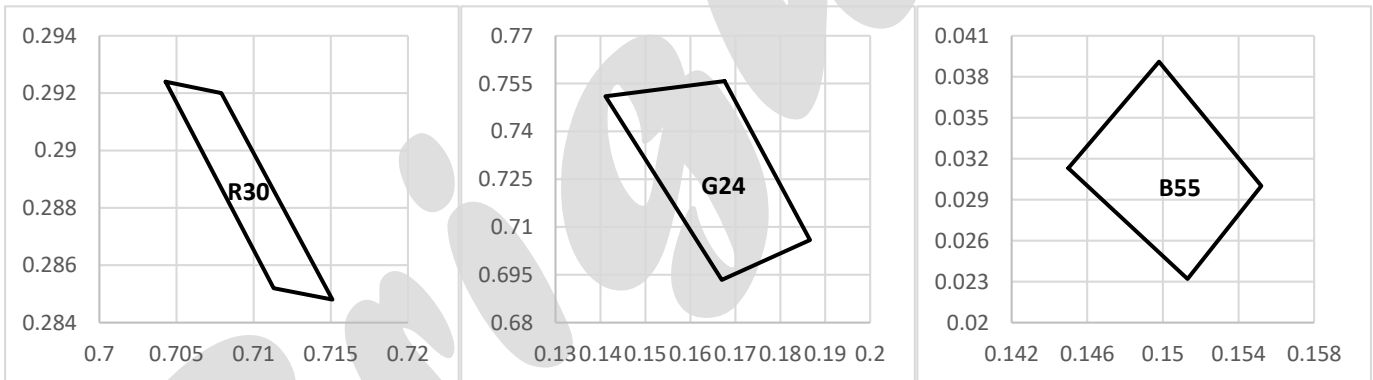

| Bin | X | Y | X | Y | X | Y | X | Y |
|-----|--------|--------|--------|--------|--------|--------|--------|--------|
| R30 | 0.7043 | 0.2924 | 0.7079 | 0.292 | 0.7151 | 0.2848 | 0.7113 | 0.2852 |
| G24 | 0.1676 | 0.7558 | 0.1411 | 0.7510 | 0.1670 | 0.6934 | 0.1866 | 0.7059 |
| B55 | 0.145 | 0.0313 | 0.1513 | 0.0232 | 0.1552 | 0.03 | 0.1498 | 0.0391 |

Tolerance of X/Y : ± 0.005

Relative Spectral Power Distribution

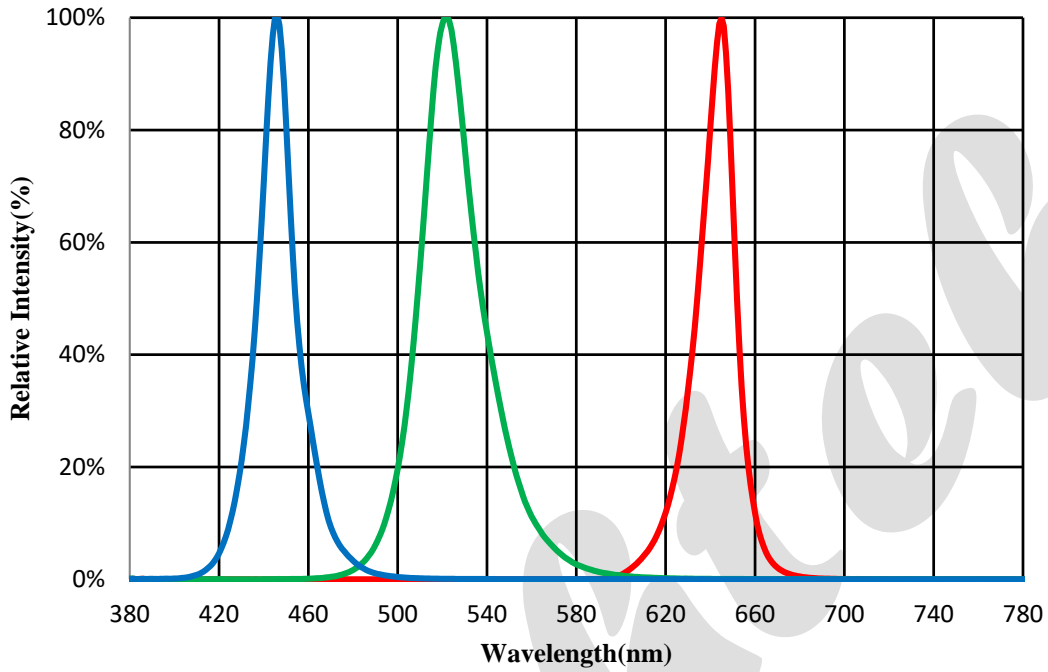

Typical Diagram Characteristics of Radiation

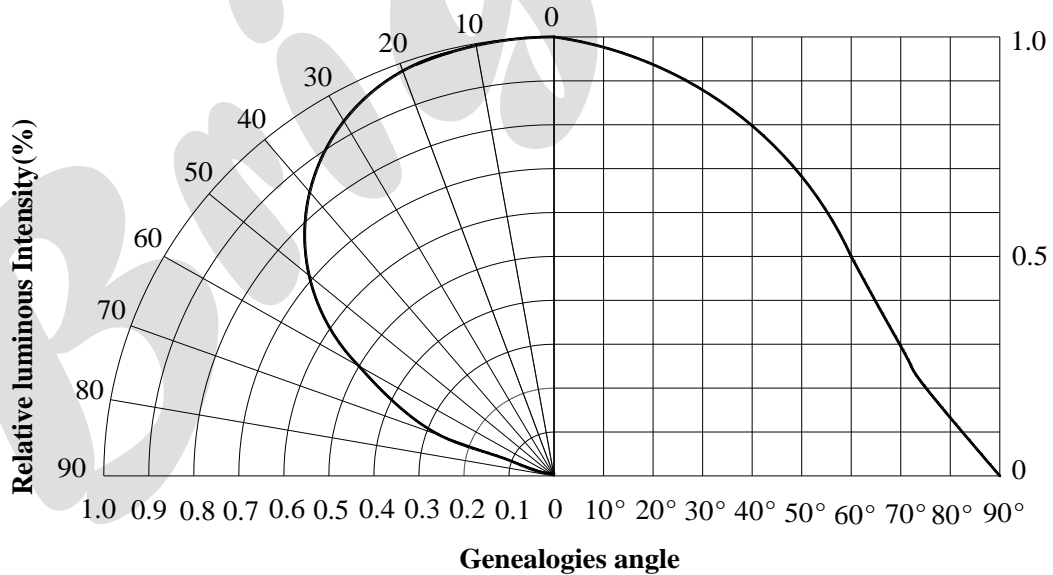

Electronic-Optical Characteristics (Full PWM)

Relative Forward Current vs. Forward Voltage Temperature

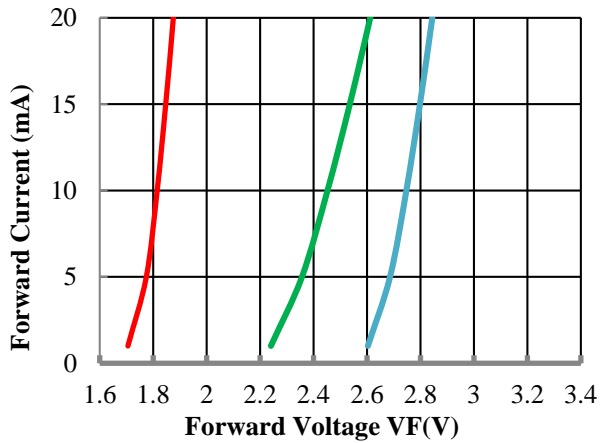

Relative Forward Voltage vs. Temperature

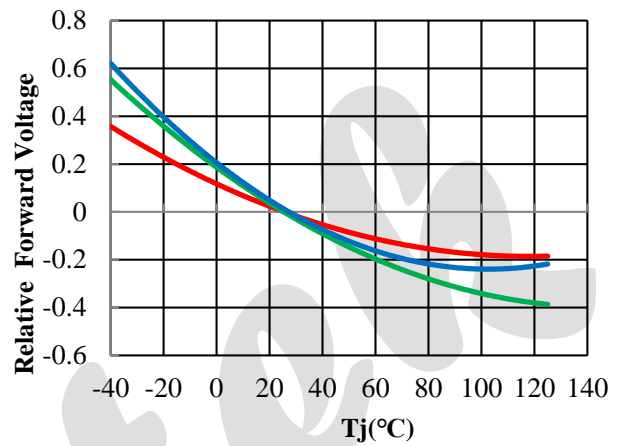

Relative Intensity vs. Forward Current

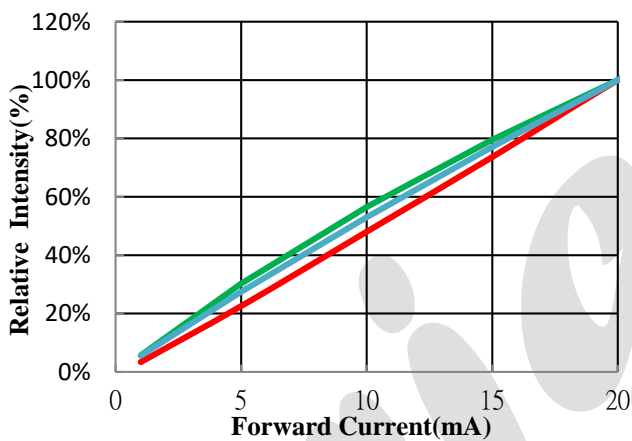

Relative Intensity vs. Temperature

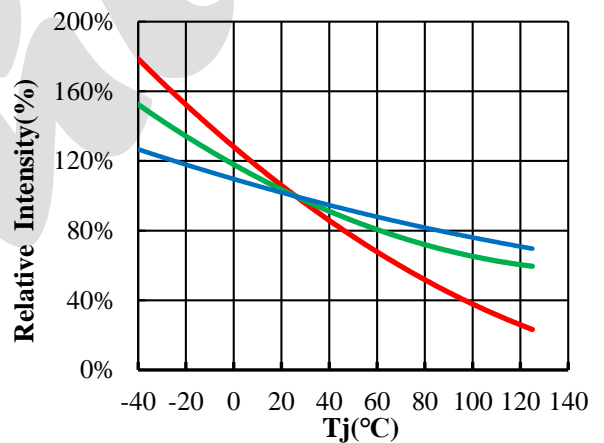

Wavelength shift vs. Forward Current

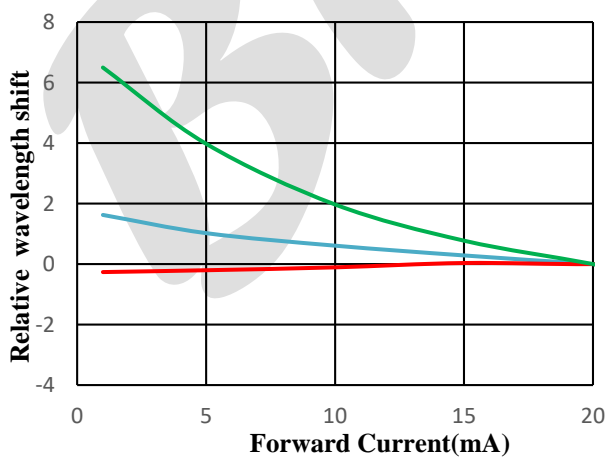

Wavelength shift vs. Temperature

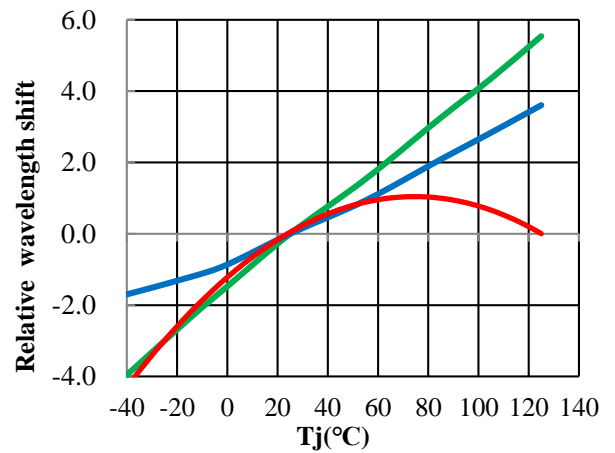

VC2020VGBCFN1

Electrical Characteristics (Ta=25°C;VDD=5V)

| Characteristics | Symbol | Condition | Min. | Typ. | Max. | Unit |
|----------------------------|---------|-----------------|------|------|---------|------|
| Supply voltage | VDD | | 4.5 | 5.0 | 5.5 | V |
| Input high voltage | VIH | | 2.7 | - | VDD+0.4 | V |
| Input low voltage | VIL | | -0.4 | - | 1.0 | V |
| The clock high level width | TCLKH | | 30 | - | - | ns |
| The clock low level width | TCLKL | | 30 | - | - | ns |
| Data set up time | TSETUP | | 10 | - | - | ns |
| Data hold time | THOLD | | 5 | - | - | ns |
| Working current(IC) | IDD | I out= "OFF" | - | - | 2 | mA |
| Static current | I sleep | Sleep mold | | | 5 | u A |
| ESD pressure | VESD | HBM | | 6000 | | V |

VC2020VGBCFN1

Function description

1. Series data structure

Tandem N-LED

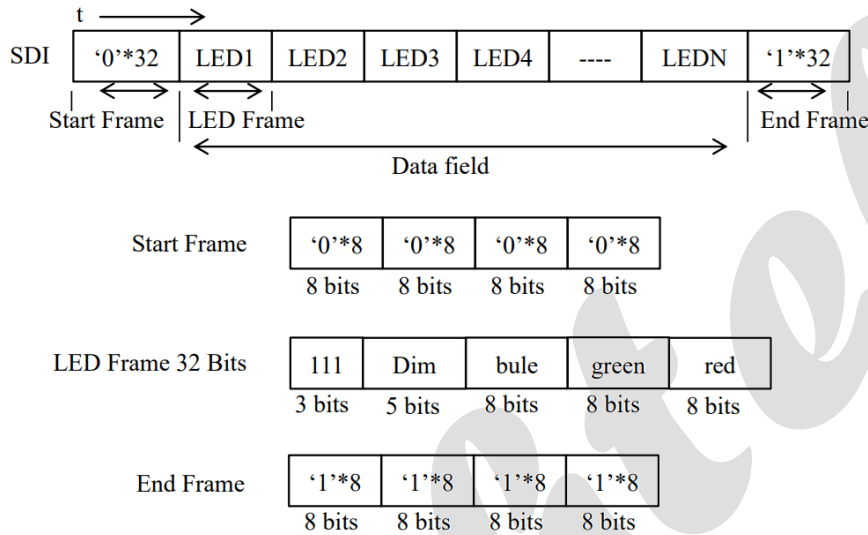

1.1 Dim 5-Bit (level 32) brightness adjustment (simultaneous control of OUTR\OUTG\OUTB three port current)

| Data MSB ← → LSB | Driving Current |
|---------------------|-----------------|
| 00000 | 0/31 |
| 00001 | 1/31 |
| 00010 | 2/31 |
| | |
| 11110 | 30/31 |
| 11111 | 31/31(max) |

1.2 PWM input/output signals relations

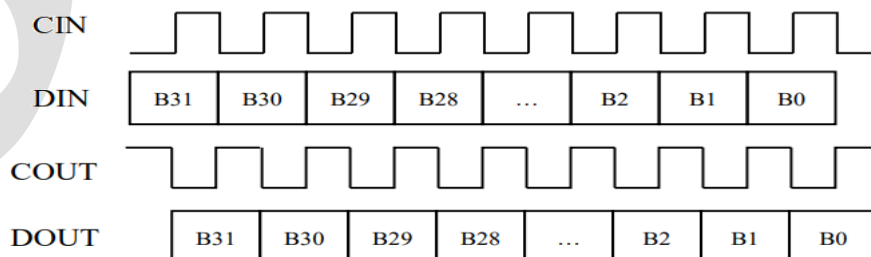

Function description

| Data MSB-- | Duty Cycle |
|---------------|--------------|
| 00000000 | 0/255(min) |
| 00000001 | 1/255 |
| 00000010 | 2/255 |
| | |
| 11111101 | 253/255 |
| 11111110 | 254/255 |
| 11111111 | 255/255(max) |

1. Sleep and power saving mode

LED supports the sleep/wake-up modes for power-saving purpose. After the IC receives 24-bit 0's BGR data (that is BLUE[7:0]=8h00, G[7:0]=8h00, R[7:0]=8h00), in the meantime, both of the data in 3-bits flag and 5-bits DIMMING is 8h' A0' (that is FLAG[2:0] =3b101 and DIMMING [4:0] =5b00000), the IC will enter sleep mode, its current is about 1uA.

The IC will wake up from sleep mode once receiving the new data with the data of Flag[2:0]、DIMMING [4:0] is not 8h"A0"; after wake-up, all sleeping circuits in IC return to normal working mode within1ms. Since it takes 1ms for a sleeping IC returning to normal function mode, it is recommended for a host to wait for 1ms to send display data and command after issuing a wake-up command

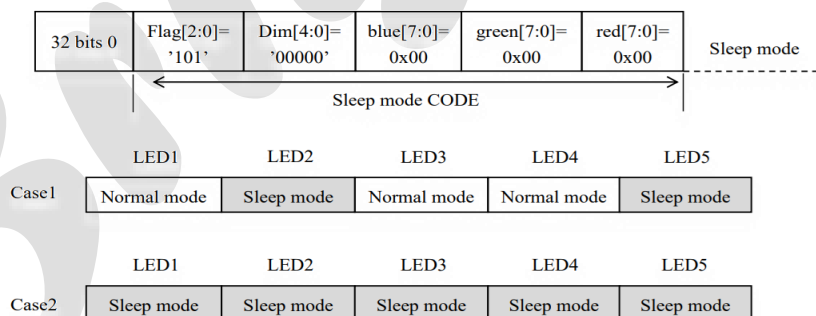

In case 1, while lamp2 is under sleep mode, in the following data transfer process, the state of lamp 2 will be not changed as long as the 32 bits data for lamp 2 is received with data of Flag[2:0]、 DIMMING[4:0] being 8h"A0" . It means lamp2 will keep in sleep mode as well. In the situation, lamp2 can pass through the remaining data to lamp 3 (32bits) to change the display data of lamp 3. In other words, the sleeping chip is able to pass the data to the next chips.

Reflow Soldering Profile

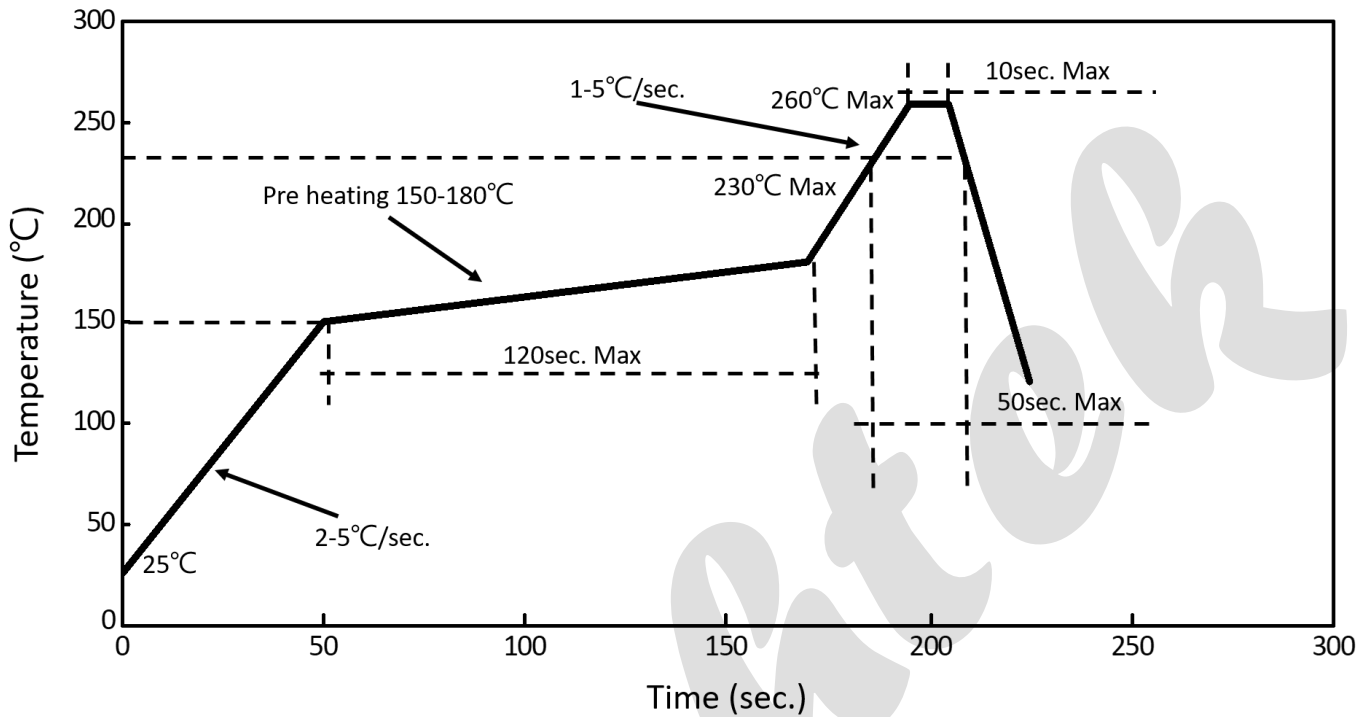

1. We recommend the reflow temperature 240°C ($\pm 5^\circ\text{C}$).the maximum soldering temperature should be limited to 260°C.
2. Do not stress the silicone resin while it is exposed to high temperature.
3. The reflow process should not exceed 3 times.

Test Circuit and Precautions for User

1. Typical application circuit

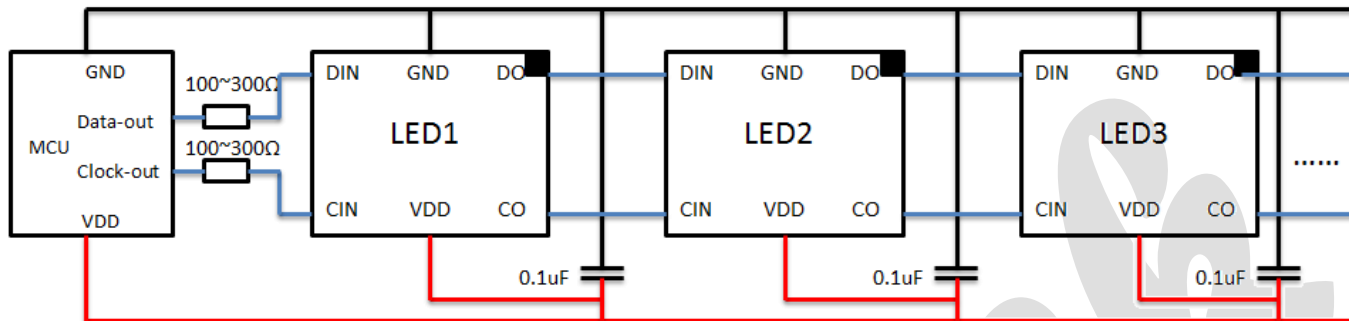

Notes:

When the first LED is connected to the MCU, a resistance R is needed in series between its signal input line and the MCU. The size of R depends on the number of cascade beads. The more cascades, the smaller resistance R is used. It is generally recommended that the value be between 100-1K. Usually the recommended value is around 300 R. In order to make the LEDs work more stably, a parallel capacitor is needed between VDD and GND of each.

2. Handling precautions

2.1 Over-current-proof

Customer must apply resistors for protection; otherwise slight voltage shift will cause big current change (Burn out will happen).

2.2 Storage

① It is recommended to store the products in the following conditions:

- Humidity: 60% R.H. Max.
- Temperature : 5°C~30°C (41°F~86°F)

② Shelf life in sealed bag: 12 month at < 5°C~30°C and < 60% R.H. after the package is Opened, the products should be used within 1 week or they should be keeping to stored at ≤ 20%R.H. with zip-lock sealed.

2.3 Baking

Suggest packing open after 1 week, before use baking products, conditions as follows:

- ① 60±3°C X 6hrs and < 5%RH, for reel
- ② 125±3°C X 2hrs, for single LED

It shall be normal to see slight color fading of carrier (light yellow) after baking in process.

VC2020VGBCFN1

Tapping

1. Dimensions of Tape (Unit: mm)

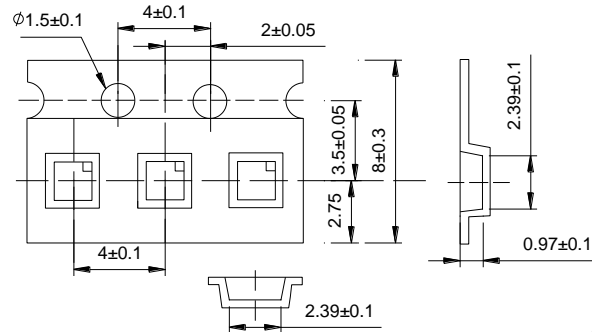

2. Arrangement of Tape

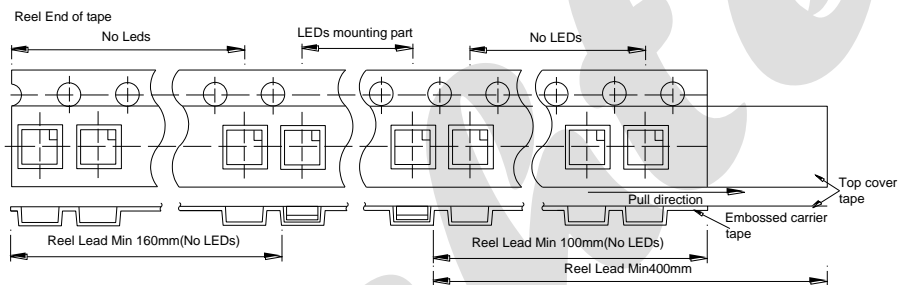

3. Dimensions of Reel (Unit: mm)

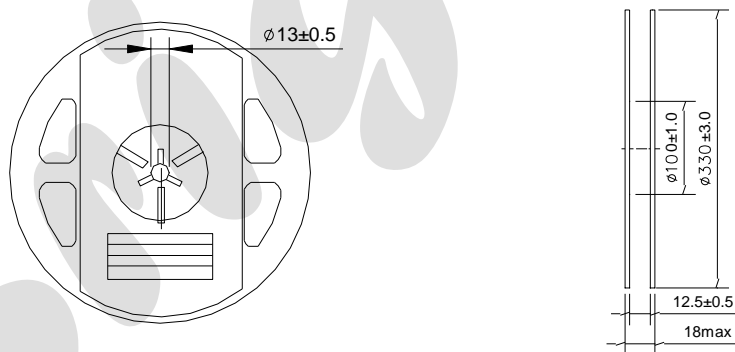

Note: 01.The tolerance unless mentioned is $\pm 0.2 \text{ mm}$.
02.The measured unit is "mm".

Notes:

1. Empty component pockets are sealed with top cover tape
2. The max loss number of SMD is 2pcs
3. The cathode is oriented towards the tape sprocket hole in accordance with ANSI/EIA RS-481 specifications
4. 4,000pcs per reel
5. The remainder packing in multiples of 500pcs.

Packing

- **Packaging Specifications**

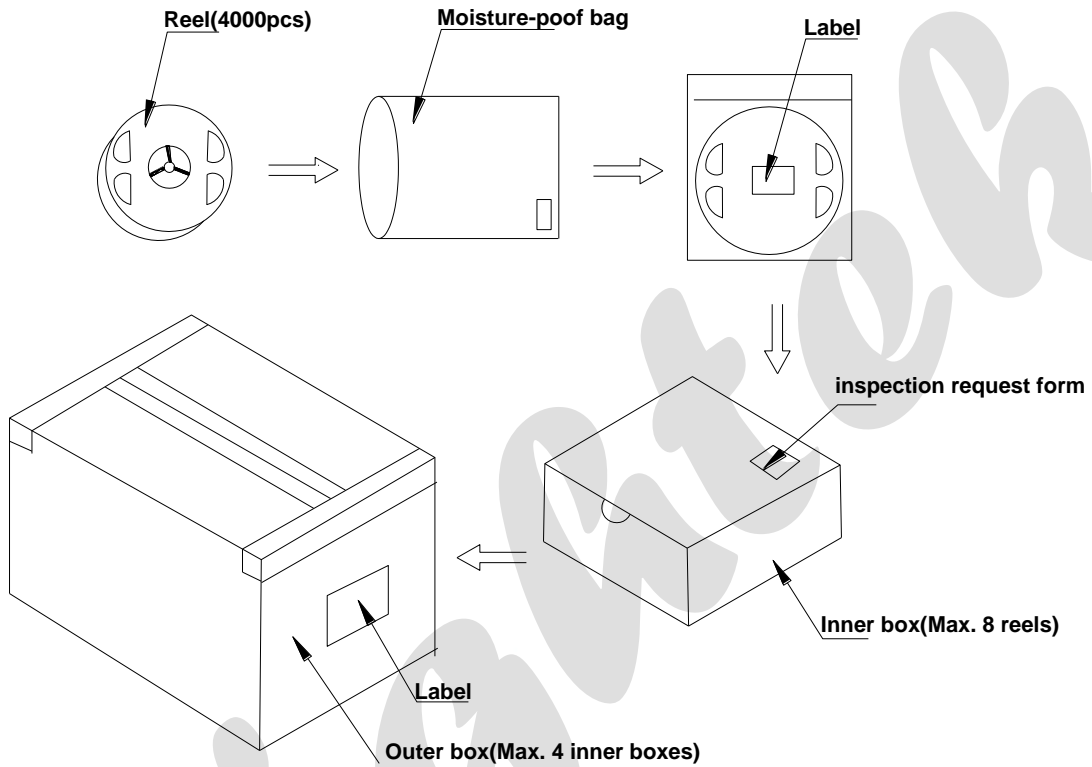

Reeled product (max.4,000) is packed in a sealed moisture-proof bag. Five bags are packed in an inner box (size: about 260 X 230 X 100 mm) and four inner boxes are in an outer box (size: about 480 X 275 X 215 mm). On the label of moisture-proof bag, there should be the information of Part No., Lot No. and quantity number; also the total quantity number should be on inspection request form on outer box.

Precautions

1. Abnormal situation caused by improper setting of collet

To choose the right collet is the key issue in improving the product's quality. LED is different from other electronic components, which is not only about electrical output but also for optical output. This characteristic made LED more fragile in the process of SMT. If the collet's lowering down height is not well set, it will bring damage to the gold wire at the time of collet's picking up and loading which will cause the LED fail to light up, light up now and then or other quality problems.

2. How to choose the collet

During SMT, please choose the collet that has larger outer diameter than the lighting area of lens, in case that improper position of collet will damage the gold wire inside the LED. Different collets fit for different products, please refer to the following pictures cross out.

Outer diameter of collet should be larger than the lighting area

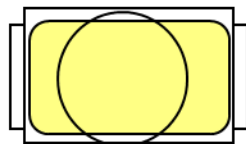

Picture 1 (✓)

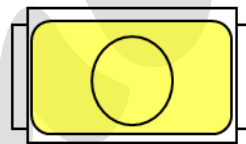

Picture 2 (X)

3. Other points for attention

- No pressure should be exerted to the epoxy shell of the SMD under high temperature.
- Do not scratch or wipe the lens since the lens and gold wire inside are rather fragile and cross out easy to break.
- CLED should be used as soon as possible when being taken out of the original package, and should be stored in anti-moisture and anti-ESD package.

4. This usage and handling instruction is only for your reference.

Disclaimer

1. Brightek reserves the right(s) on the adjustment of product material mix for the specification.
2. The product meets Brightek published specification for a period of one year from date of shipment.
3. The graphs shown in this datasheet are representing typical data only and do not show guaranteed values.
4. When using this product, please observe the absolute maximum ratings and the
5. instructions for using outlined in these specification sheets. Brightek assumes no responsibility for any damage resulting from the use of the product which does not comply with the absolute maximum ratings and the instructions included in these specification sheets.
6. These specification sheets include materials protected under copyright of Brightek. Reproduction in any form is prohibited without obtaining Brightek's prior consent.
7. This product is not intended to be used for military, aircraft, life sustaining or life saving applications or any other application which can result in human injury or death. Please contact authorized Brightek sales agent for special application request.